

G S M D O O R I N T E R C O M

GDI

User and programming manual V 2.0

Basic technical parameters:

Power supply:	12 (9-24) V AC/DC, 500mA (optionally integrated ACU 2000mAh for cca 48h of operation)
GSM :	850/900/1800/1900 MHz
dimension:	185 mm x 99 mm x 40 mm
buttons:	1 or 2 up selected casing (for every button max. 7 phone numbers dialled progressively)
relay:	2x relay with switching contact
Input:	0/5V

Basic features:

GSM Door Intercom is usefull for different installation. You just insert SIM card and connect power supply, eventually connect el.lock. For its operation is used GSM network – so you dont need any telephone line or other cables.

- Model with 1 or 2 buttons. Under each button you can programm up to 7 phone numbers which are after button press progressively dialled.
- Automatic regulation of microphone volume.
- 2 independent , remotely controlled switching relays with different ways of activation (activation by ringing or by code during call, by button press, etc...)
- Recording of numbers from which you activated the relay by ringing
- 1 input for connection for example alarm (alerting by SMS) or for control of gate(door) opening (beeps during call) etc..
- Voice signalling of different events (for example. „ wait please“, „Open“ , etc...

Function:

Hands free GSM phone with preprogrammed phone numbers for 1 or 2 buttons with name cards:

1. **Outgoing call:** After button press is dialled first number from saved list of numbers. The numbers are saved under names ABUTTON1 to ABUTTON7 – it means first number under name ABUTTON1. When called party is busy or not available then automatically second number under name ABUTTON2 is dialled etc.. When called party picks up the call the connection is established and next numbers are not dial (the same valid for second button and line BBUTTON).
2. **Incoming call:** up settings will be incoming call picked up either for all calls or for saved numbers on SIM card only. (connection for saved numbers only). GDI might also reject incoming calls (see later in relay function). Before picks up might GDI alert by preprogrammed melody (adjustable) . (Notification for call establishing – listen in control).

2 remotely controlled switching relay. Each can be controlled up settings by different ways:

1. **By ringing** – at SIM card of GDI is saved phone list. When incoming call generates number from this list the call is rejected (confirmation of command accept) and simultaneously is activated selected relay for preprogrammed time. The list of numbers used for this activation (including time) might be sent by SMS to preprogrammed number.
2. **By code** – during voice communication (incoming as same as outgoing call) . The 1 digit code by DTMF might be dialled by called party for relay activation (for preprogrammed time). For each relay you can programm different code.

3. **By SMS** – you can remotely switch ON/OFF selected relay or activate relay for certain time mention in SMS. Relays might be controlled only from preprogrammed numbers at GDI SIM card.
4. **camera mode** – selected relay is ON by picking up the call and it is OFF by hanging up the call.
5. **lighting mode** – selected relay is ON by picking up the call and it stays ON for preprogrammed time after hang up.
6. **button mode** – selected relay is ON after button press and stays ON for preprogrammed time.

1 adjustable input :

1. **SMS sending** „ALARM ON“ to preprogrammed number when input is short circuit against ground. SMS „ALARM OFF“ to next preprogrammed number when input is disconnected. It might be programmed 1 number only (ON/OFF). Then is send 1 SMS only up selected status.
2. **opening detection.** When input is activated during call (for example by gate (door) opening) the GDI generates into a call 3 short beeps for time of input activation.

Voice signalling of different status. Up settings might be different status signalling by voice . (language adjustable). When is voice signalling presented during a call it is hearable on both sides of connection (for example „open“)

Installation

Assembly of front panel

CAUTION! During assembly of front panel you might connect/disconnect speaker connector (via schematics)

Assembly of cards backlighting

GDI Wall mounting

Wall mounting assembly you make by attached screws (5mm).

Replacing backlighting cards after wall mounting

Cards inserting (name cards)

Every button has individual card hold by plastic flag. (via picture).

Control elements and connection

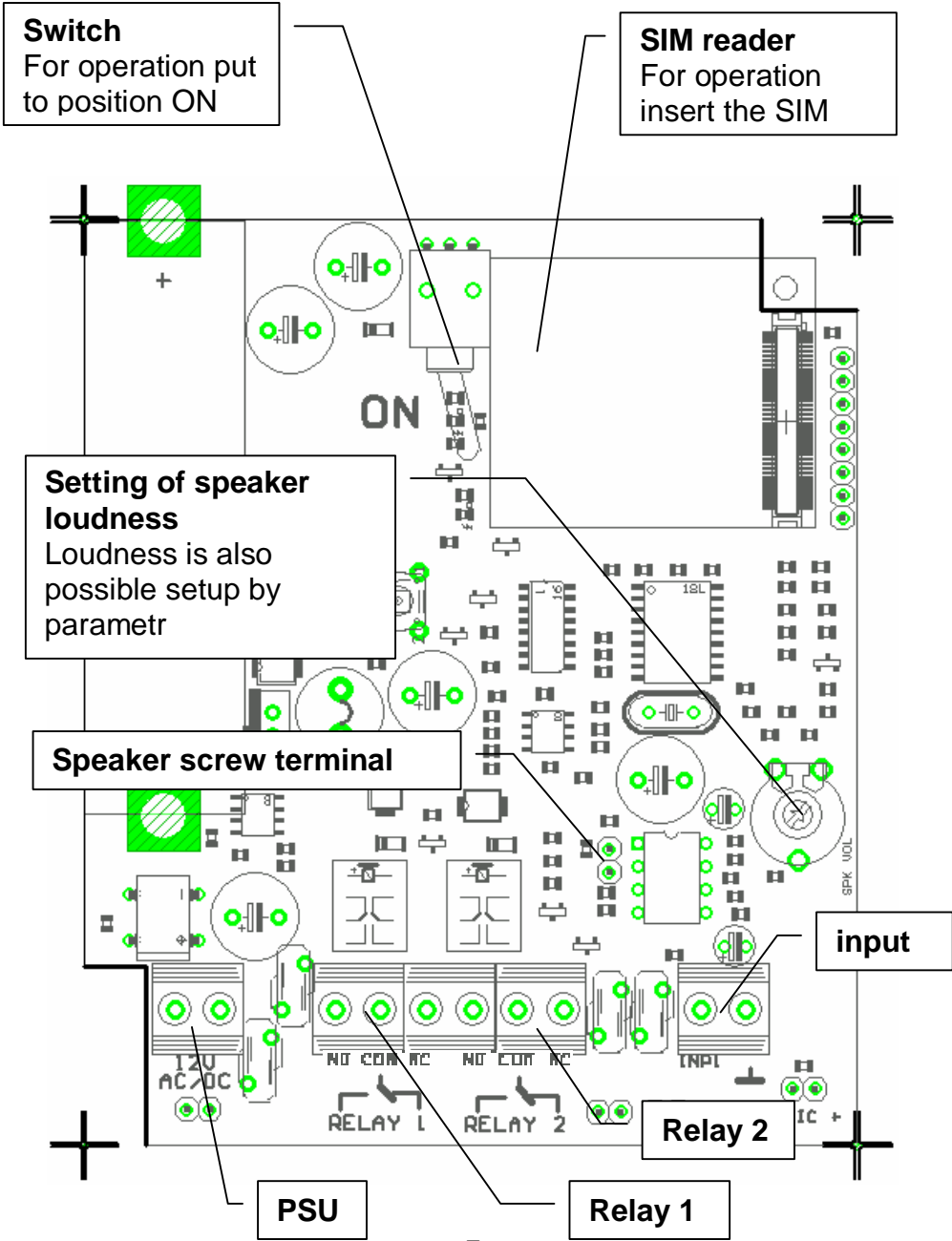

Examples of relay connection

1. Basic connection - 2 electrical locks and possibility control 2 doors (gates)
2. 2x PSU – possibility to use 2x independent PSU. One for GDI and second for electrical locks. The electrical lock 2 is connected inversaly (fire emergency doors).
3. External camera or lighting activation.
4. Electrical lock and additional bell combination.

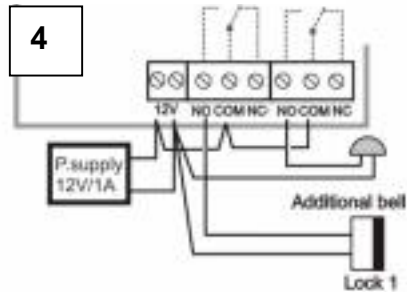
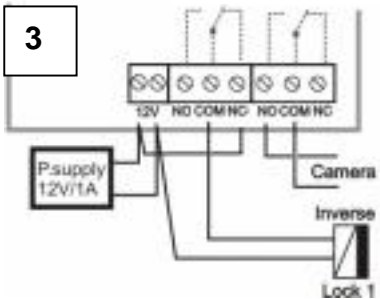
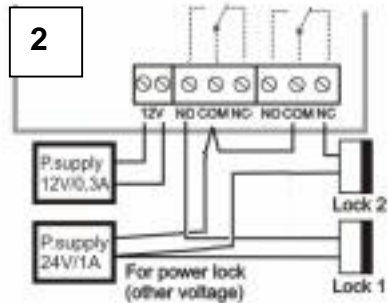
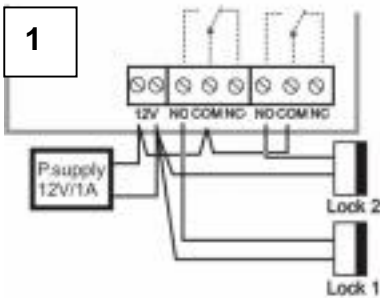

CAUTION! Relay contacts cant close 230V directly.To control directly 230V devices you must use contactor.

Start

1. connect antenna and insert the SIM



We recommend use SIM without PIN. When you need PIN setup PIN 1234.

Release the SIM holder (1).

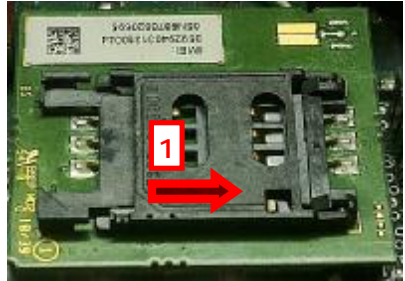

Move it up (2).



Insert the SIM in correct position (3) to the holder. Close the SIM holder (4).

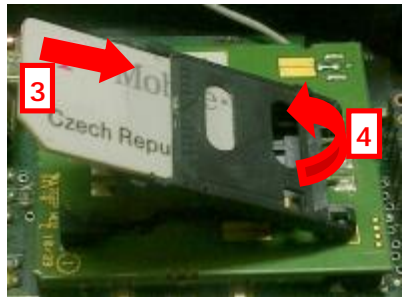

Pull the SIM holder for lock up (5)

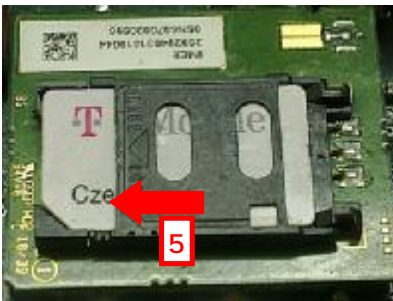

Note: All programmed parameters are saved on the SIM. The SIM you can insert into GDI already preprogrammed or setup GDI after switching ON (via below).

When you want use calls rejection (ringing), ask your GSM provider to switch OFF voice mail at used SIM card!

SIM preprogramming

1. SIM which you desire to use insert to various mobile phone.
2. When PIN is setup – cancel it (or setup PIN to 1234)
3. When you will want to make remote setting save on the SIM phone number of desired mobile under name ADMIN1.
4. On the SIM save phone number which should be dial after pressing button 1 (A), under name „ABUTTON1“.
5. When you have GDI with 2 numbers – save on the SIM also phone number which will be dial after pressing button 2 (B) , under name „BBUTTON1“.
6. When you want dial automatically next numbers (when first number is busy or not available) then save those numbers under appropriate names ABUTTON2..7 and BBUTTON2..7
7. Similarly you can program setting of all parameters (programming table at the end of manual)

The way of phone numbers saving on the SIM depends on mobile phone type. **Please double check that you save numbers to SIM card and not to internal mobile phone memory!**

2. Switch on GDI

When all necessary cables are connected (relay, locks, etc.) CAUTION: antenna must be also connected. Then connect speaker connector and connect PSU. The RED LED lights on and after a while yellow LED start flashing (via table). The GDI signalling by tones or by voice SIM reading, GSM network registration and ready for operation (via table). Now you can put on front panel of GDI but dont screw it.

When SIM is preprogrammed you can try first connection – push the button. The GDI must dial programmed phone number. When SIM is not preprogrammed then first step is SIM programming (via following article (3)) and then try connection. After voice connection you can adjust setting of speaker volume. Then screw up front panel of GDI.

3. Programm GDI parametres

The parametres in GDI (must be switch on) you can programm by 2 ways. By SMS or by PC (special sw) via USB port.

A) Programming by SMS.

Due security reasons you can programm GDI parametres from authorised numbers only. They are saved on SIM under names ADMIN1 to ADMIN9.

SMS are always written by BIG LETTERS

Each SMS elements are splited by space (words). First word is always command. Further word (s) is one or more parametres.

Example: **INIT ADMIN1 +420123456789**

All commands are in appropriate table at the end of manual

1. During first setting when SIM doesn't contain any ADMINx name is necessary such number insert to SIM by SMS with command INIT. SMS you can send from various number. When SIM already contains even one number under name ADMINx the command is ignored.
2. When you need control relay eventually setup GDI from next ADMIN numbers perform following: from mobile phone with ADMINx number send progressively SMS to GDI with numbers of next ADMINx in SMS format: WRITE ADMIN2 +420xxxxxxxx (WRITE ADMIN3... etc.)
3. From mobile phone with numbers ADMINx send progressively SMS to GDI with numbers which should be dial after button press, SMS format: WRITE ABUTTON1 +420xxxxxxxx (WRITE BBUTTON1... etc..)
4. Up your needs send next SMS with other parameters for opening by ringing, SMS alarm sending , etc..
5. Setup parameters GDI (via table). Parameters you can setup individually for each parameter appropriate SMS. When you need setup more parameters simultaneously we recommend use SMS for batch setting. By SMS „READ PAR“ read firstly current setting to your mobile. By editor of SMS messages change at received SMS word READ to WRITE as same as adjust parameters up your needs. Such adjusted SMS send back to GDI as reply. The parameters will be setup.

A) Setting by PC through USB via GDlset (optional)

1. Connect MiniUSB cable to PC as same as to programming module – green LED must light on at the module. During first usage USB driver might be installed. USB driver is available at attached CD.



2. Remove front cover of GDI and insert connector of programming modul into GDI (via picture). On programming modul must light on red LED (It is flashing same way like yellow LED on GDI)
3. Run GDiset programm and setup appropriate port.
4. Program control GDI connection. After that display GSM signal strength and voltage on GDI (back up ACU). Now you can programm:

Monitor mode

For parametres programming stop firmware running in GDI. For operation monitoring dont press! Stop GDI running!

Identification of serial line connection

After GDI voice connection will show voltage in GDI

After GDI voice connection will show GSM signal strength

After click to button monitor is shown GDI operation (when operation is not stopped by button STOP)

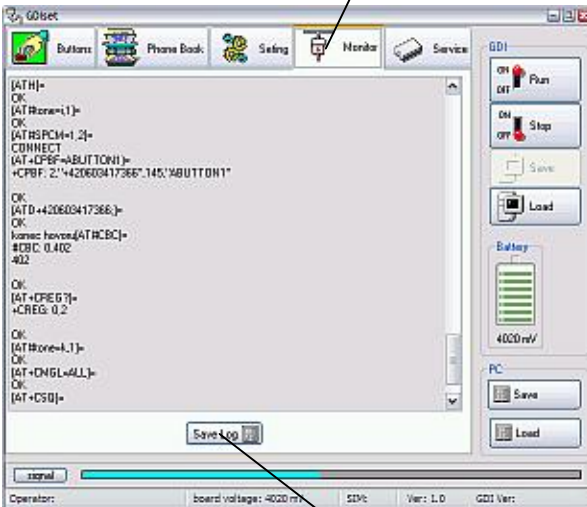

Record savings from monitor to file (for service purposes – record sending)

Programming mode

After button press STOP programm sends to GDI command for stop and wait for GDI response (via)



Waiting for GDI response

Item Buttons

It is designed for programming phone numbers under each buttons

Item for 1 button

Field to programm up to 7 phone numbers

Item for 2 buttons

Field to programm up to 7 phone numbers for upper button

Saving of all programmed parametres including numbers to GDI

Reading of all programmed parametres including numbers from GDI

Saving of all programmed parametres including numbers to PC

Reading of all programmed parametres including numbers from PC

GDIset version and fw GDI

SIM number of position

GSM provider where is GDI registered

Field to programm up to 7 phone numbers for second button

Item Phone Book

Phone book of authorised numbers for ringing opening as same as automatic call receiving.

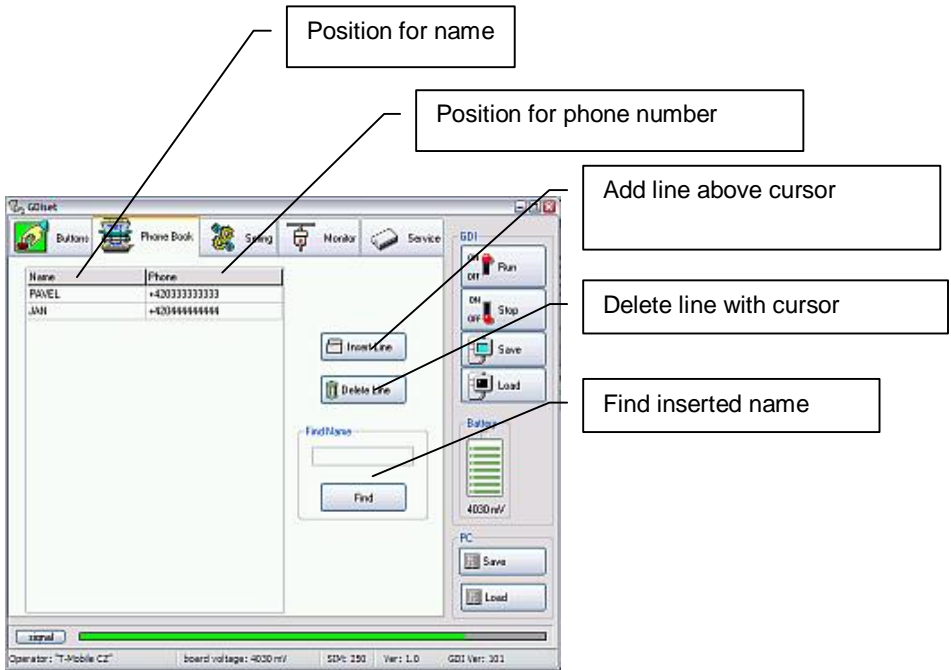

Item Setting

Item Calls

Loudness of speaker setting

Loudness of microphone setting

Way of incoming call receiving:
- reject (opening by ringing)
- automatically picked up calls from numbers at list only
- pick up all calls

Signalization
- Informing GDI tones
- Ringing during incoming call
- Voice signalling

The screenshot shows the GDI (Global Display Interface) settings menu. The 'Incoming Call Pick-Up' section has three radio button options: 'No-ringing switch' (selected), 'only from SIM', and 'All'. The 'Info Tones' section has three checkboxes: 'Beeps' (checked), 'Ring Tones' (unchecked), and 'Voice Messages' (checked). The 'Volume Speaker' and 'Volume Mic' sliders are visible on the left. The status bar at the bottom shows 'Operator: T-Mobile CZ', 'board voltage: 4030 mV', 'SIM: 250', 'Ver: 1.0', and 'GDI Ver: 301'.

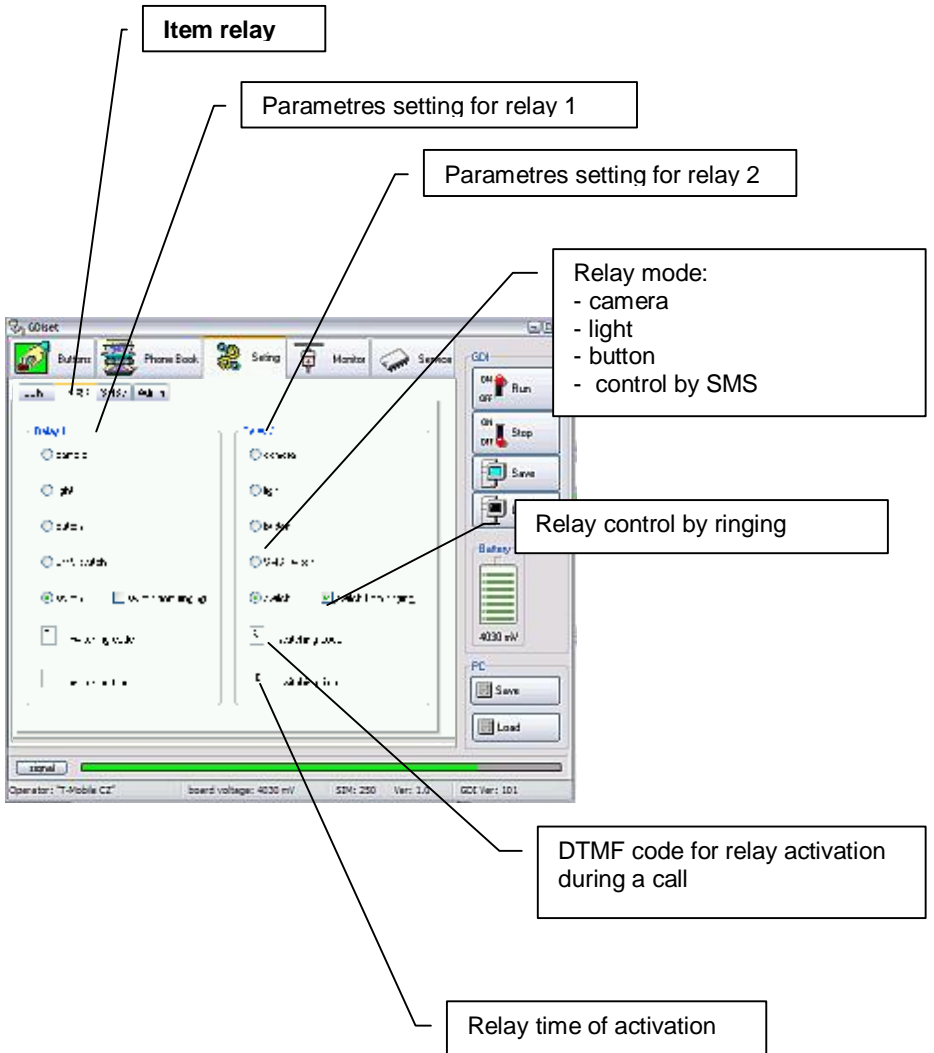

Item SMS

Number where will be sent SMS „ALARM ON” when input is activated

Number where will be sent SMS „ALARM OFF” when input is deactivated

Input mode:

- Input deactivated
- Tones when input is activated during a call (open signal)
- sending SMS

Sending SMS to ADMIN1 with list of numbers which activated relay by ringing.

Activation of time settings from GSM network

Item ADMIN numbers setting

Field to save up to 7 ADMIN numbers

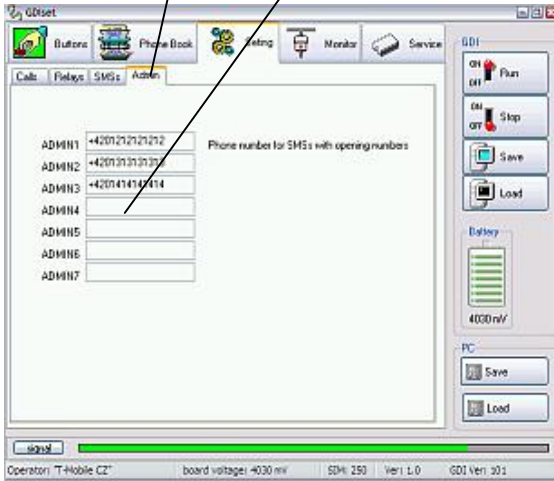

Item Service

It is designed for upgrade of firmware and voice messages in GDI.

CAUTION! Unauthorised manipulation can blocked the unit.

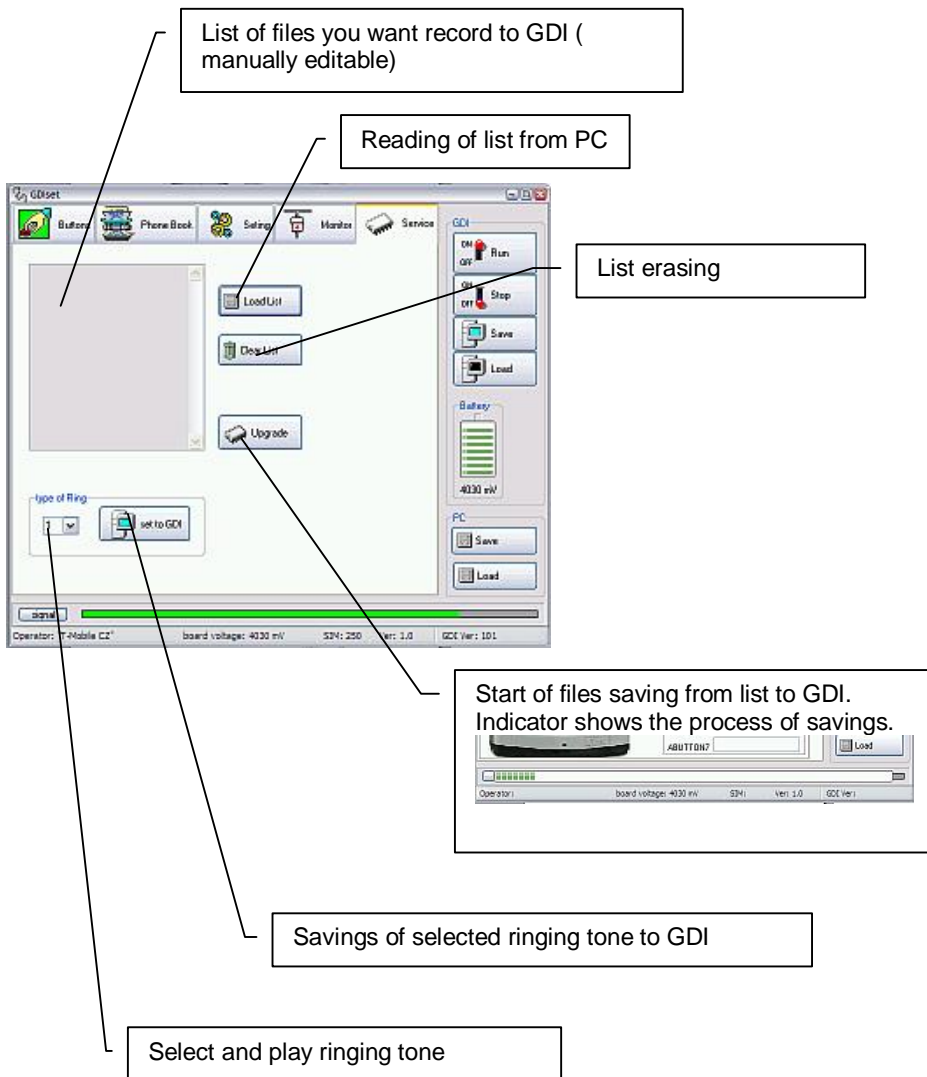

When all necessary is setup then save it by button Save to GDI.

Return from programming mode to monitor mode (restart of GDI)

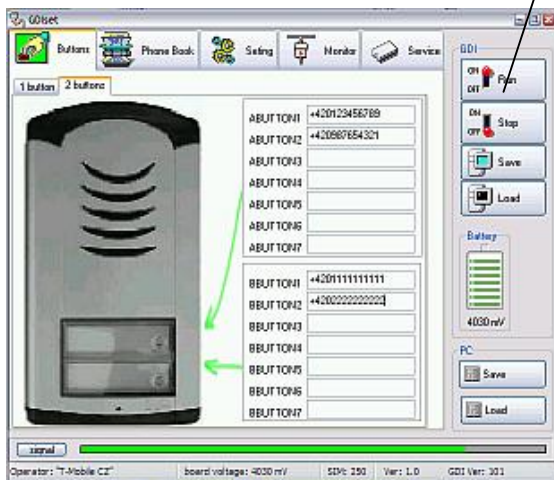

To return to monitor mode (run GDI) click on button „Run“. Programm detects GDI runs the same way like stop:

GDI behaviour after restart is the same like during power supply connection (tones, eventually voice messages).

Table of SMS commands

command (SMS)		Functionality	Des
SMS might be sent from ADMINx numbers only	READ STAT	Reading of GDI status (firmware, time, relays status etc.)	
	READ PAR	Reading of all setup parametres	
	READ JMENO	Reading of phone number for NAME	
	CLR JMENO	Erasing phone number for NAME	
	INIT ADMIN1 +420cc...c	Inicialization – first GDI setting – parametres you can programm from number ADMIN1 +420cc..c	
	SET REL1 ON	Activation relay 1	
	SET REL1 OFF	Deactivation relay 1	
	SET REL1 ON xx	Activation relay1 for xx minutes (xx=00 -99)	
	SET REL2 ON	Activation relay 2	
	SET REL2 OFF	Deactivation relay 2	
	SET REL2 ON xx	Activation relay 2 for xx minutes (xx=00 -99)	
	WRITE JMENO +420cc...c	Saving of phone number under NAME	
	WRITE PAR VOLIN:x	Saving of microphone loudness [x=1-7]	4
	WRITE PAR VOLOUT:x	Saving of speaker loudness [x=1-7]	4
WRITE PAR INCALL:x	Processing of incoming call: x: 0 – calls rejected (ringing in) 1- calls received from SIM only (list) 2 – all calls received	0	
WRITE PAR TMGSM:x	Time setup up GSM network x: 0 – OFF 1 - ON	1	

	WRITE PAR TONE:x	Setting of acoustic signalization x: 0 – switch OFF 1 – signalling by service tones 2 – ringing of incoming call is ON 4 – signalling by voice messages and combination – for ex. 7 – all is ON	5
	WRITE PAR INPMOD:x	Input mode x=0 – deactivated x=1 – beeps into call (opening indication) x=2 – during activation/deactivation sends SMS	0
SMS might be sent from ADMINx numbers only	WRITE PAR RL1COD:y	Code for relay1 activation during call y= 0-9	5
	WRITE PAR RL1MOD:x	Relay 1 modes x=0 – control by SMS x=1 – switch mode (ringing in or by code) x=2 – camera mode (activated by pick up, deactivated by hang up) x=3 – lighting mode (activated by pick up and stays ON for „activation time“ after hang up) x=4 – activated for „activation time“ after button press	1
	WRITE PAR RL1TMON:y	Relay1 activation time after ringing in or by code yy seconds y=0-9	03
	WRITE PAR RL1RING:x	Relay1 activation by ringing in x=0 – OFF x=1 - ON	1
	WRITE PAR RL2COD:yy	Code for relay2 activation during call yy= 00-99	6

WRITE PAR RL1MOD:x	Relay 2 modes x=0 – control by SMS x=1 – switch mode (ringing in or by code) x=2 – camera mode (activated by pick up, deactivated by hang up) x=3 – lighting mode (activated by pick up and stays ON for „activation time“ after hang up) x=4 – activated for „activation time“ after button press	0
WRITE PAR RL2TMON:yy	Relay2 activation time after ringing in or by code yy seconds yy=00-99	05
WRITE PAR RL2RING:x	Relay2 activation by ringing in x=0 – OFF x=1 - ON	0
WRITE ALARMON +420cc..c	Savings of number for SMS „ALARM ON“ (input grounding)	
WRITE ALARMOFF +420cc..c	Savings of number for SMS „ALARM OFF“ (input disconnection)	
CAL AT+CSQ	Signal strength level	
CAL AT+CPBR=x	Info about number saved on position x	
CAL AT+ĈCLK= <time>	Setup time in GDI <time> Format <time>= yy/MM/dd,hh:mm:ss±zz yy – year (00-99) MM – month (01-12) dd – day (01-31) hh – hours (00-23) mm – minutes (00 – 59) ss – seconds (00 – 59) ±zz – time zone (-47..+48) hours	

Command types:

READ – command for reading parameters as same as phone numbers from SIM card

CLR – command to erase phone numbers from SIM card.

CAUTION! When you use SMS for numbers erasing then don't forget that one ADMINx number must stay – otherwise remote settings will not be possible (necessary to make new initialization).

INIT – Initialization. During first setting when SIM doesn't include any ADMINx number is necessary to put such number on the SIM card. It is done by SMS with INIT command. The SMS might be sent from various number. When SIM card already has at least one number with name ADMINx the command is ignored.

WRITE – command to save parameters as same as phone numbers to SIM card

CAL – after command CAL you can put various AT command of used GSM module (for example: module reset, time setting etc.) . **Those commands please use with appropriate knowledge only! It can cause blocking of whole unit!**

Names function saved in phone book

NAME	function
ABUTTON1	<ul style="list-style-type: none"> - to this number GDI call when button is pressed (upper button) - relay1 or relay2 activated by ringing in - calls are automatically received from this number
ABUTTON2	<ul style="list-style-type: none"> - to this number is called from GDI when number under ABUTTON1 is busy, unreachable, not picked up a call for certain time - relay1 or relay2 activated by ringing in - calls are automatically received from this number
ABUTTON3	<ul style="list-style-type: none"> - to this number is called from GDI when number under ABUTTON2 is busy, unreachable, not picked up a call for certain - relay1 or relay2 activated by ringing in - calls are automatically received from this number
ABUTTON4	<ul style="list-style-type: none"> - to this number is called from GDI when number under ABUTTON3 is busy, unreachable, not picked up a call for certain - relay1 or relay2 activated by ringing in - calls are automatically received from this number
ABUTTON5	<ul style="list-style-type: none"> - to this number is called from GDI when number under ABUTTON4 is busy, unreachable, not picked up a call for certain time - relay1 or relay2 activated by ringing in - calls are automatically received from this number
ABUTTON6	<ul style="list-style-type: none"> - to this number is called from GDI when number under ABUTTON5 is busy, unreachable, not picked up a call for certain time - relay1 or relay2 activated by ringing in - calls are automatically received from this number
ABUTTON7	<ul style="list-style-type: none"> - to this number is called from GDI when number under ABUTTON6 is busy, unreachable, not picked up a call for certain time - relay1 or relay2 activated by ringing in - calls are automatically received from this number

BBUTTON1	<ul style="list-style-type: none"> - to this number GDI call when down button is pressed (version with 2 buttons) - relay1 or relay2 activated by ringing in - calls are automatically received from this number
BBUTTON2	<ul style="list-style-type: none"> - to this number is called from GDI when number under BBUTTON1 is busy, unreachable, not picked up a call for certain time - relay1 or relay2 activated by ringing in - calls are automatically received from this number
BBUTTON3	<ul style="list-style-type: none"> - to this number is called from GDI when number under BBUTTON2 is busy, unreachable, not picked up a call for certain time - relay1 or relay2 activated by ringing in - calls are automatically received from this number
BBUTTON4	<ul style="list-style-type: none"> - to this number is called from GDI when number under BBUTTON3 is busy, unreachable, not picked up a call for certain time - relay1 or relay2 activated by ringing in - calls are automatically received from this number
BBUTTON5	<ul style="list-style-type: none"> - to this number is called from GDI when number under BBUTTON4 is busy, unreachable, not picked up a call for certain time - relay1 or relay2 activated by ringing in - calls are automatically received from this number
BBUTTON6	<ul style="list-style-type: none"> - to this number is called from GDI when number under BBUTTON5 is busy, unreachable, not picked up a call for certain time - relay1 or relay2 activated by ringing in - calls are automatically received from this number
BBUTTON7	<ul style="list-style-type: none"> - to this number is called from GDI when number under BBUTTON6 is busy, unreachable, not picked up a call for certain time - relay1 or relay2 activated by ringing in - calls are automatically received from this number

ADMIN2 to ADMIN7	<ul style="list-style-type: none"> - by ringing in activate relay 1 and relay 2 - Activate relay 1 and relay 2 by SMS - Read GDI status and numbers in phone book by SMS - Edit name and numbers on SIM card by SMS - Control next features by SMS (AT commands) - Setup parametres by SMS - calls are automatically received from this number
ADMIN1	<p>The same like ADMIN2 to ADMIN7 and moreover:</p> <ul style="list-style-type: none"> - to this number are sending reports by SMS includes list of relay activation by ringing in - to this number is sending SMS with message about low battery level (option)
Various name	<ul style="list-style-type: none"> - relay1 or relay2 activated by ringing in - calls are automatically received from this number
ALARMON	- to this number is send SMS „ALARM ON“ when input is activated against ground
ALARMOFF	- to this number is send SMS „ALARM OFF“ when input is deactivated
VER	- firmware version in GDI - just info – do not adjust!
PARGDI	<ul style="list-style-type: none"> - GDI parametres A#B#C#D#E#F#G#H (default 4#4#0#0#1#5#0#0) A – microphone sensitivity [1-7] B – speaker loudness [1-7] C – incoming calls: 0 – all rejected (ringing in relays activation) <ul style="list-style-type: none"> 1 – accept from numbers on SIM card only 2 – accept all D – record who opened by ringing in: 0 – deactivated <ul style="list-style-type: none"> 1 – activated E – time setup from GSM network: 0 – deactivated <ul style="list-style-type: none"> 1 – activated F – signalization: 0 – OFF <ul style="list-style-type: none"> 1 – tones 2 – ringing of incoming call 4 – voice messages all combination available – for ex. All is ON = 7

	<p>G – input mode: 0 – input deactivated 1 – when input is grounded beeps into call (signalling of opened door) 2 – SMS when input is activated/deactivated</p>
PARRL1	<p>- parametres for relay 1</p> <p>A#B#CC#D (default 5#1#03#1)</p> <p>A – DTMF code for relay activation during call [0-9] B – relay mode: 0 – SMS mode, control by SMS 1 – switch mode, activated by ringing in of by DTMF code during call 2 – camera mode (activated by pick up, deactivated by hang up) 3 – lighting mode (activated by pick up, stays activated for „activation time“ after hang up 4 – button mode (activated for „activation time“ after button press CC – activation time [00-99] D – relay activation by ringing in: 0 – deactivated 1 - activated</p>
PARRL2	<p>- parametres for relay 2</p> <p>A#B#CC#D (default 6#0#05#0)</p> <p>A – DTMF code for relay activation during call [0-9] B – relay mode: 0 – SMS mode, control by SMS 1 – switch mode, activated by ringing in of by DTMF code during call 2 – camera mode (activated by pick up, deactivated by hang up) 3 – lighting mode (activated by pick up, stays activated for „activation time“ after hang up 4 – button mode (activated for „activation time“ after button press CC – activation time [00-99] D – relay activation by ringing in: 0 – deactivated 1 - activated</p>

Names with numbers might be saved to phone book also by various mobile phone.(follow instruction of mobile phone manual). **Names ABUTONx, BBUTONx, ADMINx, ALARMON, ALARMOFF, PARGDI, PARRL1, PARRL2 must be written by big letters. Between names and numbers is not a space**

GDI response for SMS „READ STAT“

READ STATUS:
VER: 101
BATTERY:4030mV
TIME: "00/01/01,00:01:55"
OPER: T-Mobile CZ
INP:1
RL1:0
RL1:0

GDI response for SMS „READ PAR“





READ PAR:
VOLIN:4
VOLOUT:4
INCALL:0
WRCALL:1
TMGSM:1
TONE:5
INPMOD:2
RL1COD:5
RL1MOD:4
RL1TMON:03
RL1RING:1
RL2COD:6
RL2MOD:1
RL2TMON:05
RL2RING:1

SMS example for GDI parametres setting

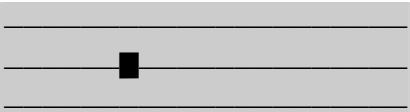

WRITE PAR:
VOLIN:1
TONE:7
INPMOD:2
RL1COD:2

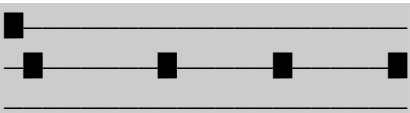
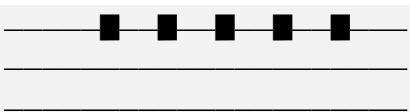
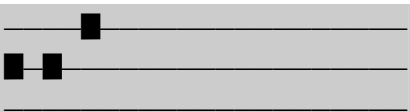
GDI tones

Except ordinary tones and signalling of GSM communication (ringing tone, busy tone, different provider's messages) the GDI has own signalling of operation (via setting possibilities).

	High tone – Alerting GDI detects not registration to GSM net (antenna not connected, wrong PIN, dialling number to GSM etc..)
	Medium level tone – verify action GDI reads the SIM, registers to network, answers for SMS, measures voltage etc...
	Low level tone – error GDI detects error (for example: low voltage, no GSM reaction for command. Can react by unit restart)
	High tone follow by medium level tones in period cca 5 sec. start a initialization of GDI (registration to network, SIM reading etc..)
	High tone repeated GDI detects disconnection from GSM net (antenna disconnected, wrong PIN....)
	Medium level tone repeated during button holding, high tone Button press detection, dial of preprogrammed number
	High tone, once after dial number to GSM called party reached

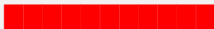
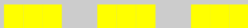
LED signalling

Red LED		Permanent light GDI power supply is ON
		Not light GDI switched OFF
Yellow LED		Not light GDI switched OFF
		Flashing space and light same duration GDI is not registrated to GSM network
		Short flashing with frequency 2 sec. GDI registrated to GSM network
		Permanent light GDI establish a call or it is a call

Inserting the backup battery:

- The work may make only by a person with sufficient knowledge.
- Use only batteries approved by the manufacturer.
- Observe the polarity. Never place the inverted battery! It can damage the device.

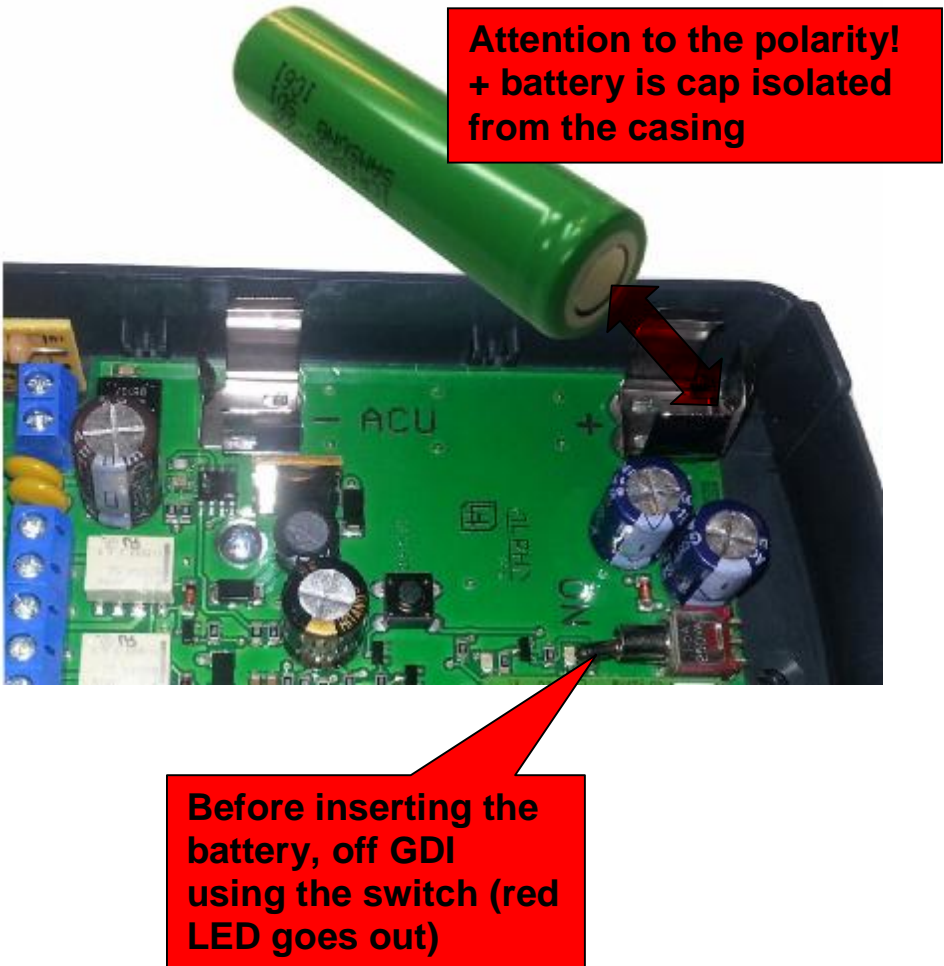

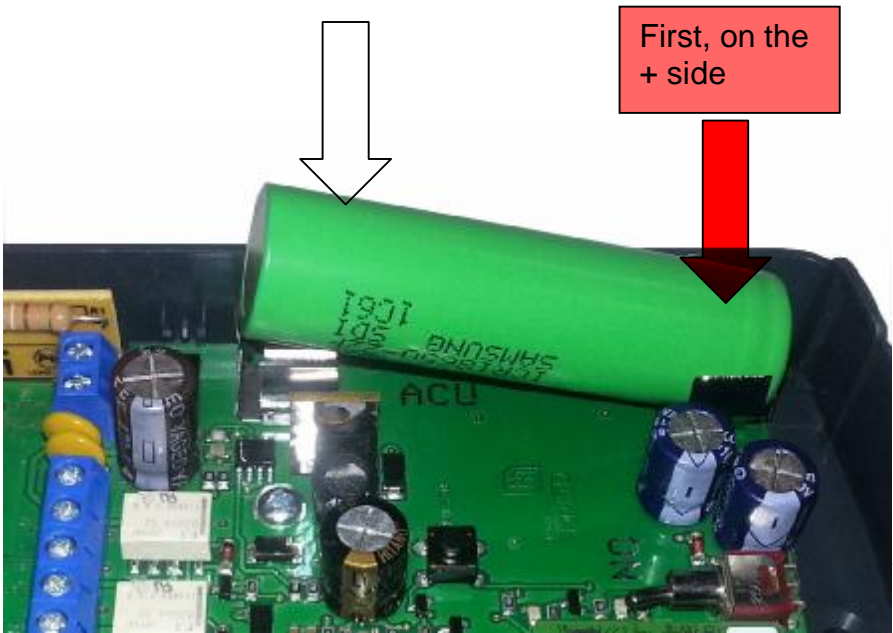

The manufacturer is not liable for defects caused by failure to comply with the prescribed procedure.

Technical parametres:

Dimension	185 mm x 99 mm x 40 mm
Operating position	various
Operating condition	temperature: -20 to + 50°C humidity: 10% ÷ 80% při 30° C
Power supply	12 (9-24) V AC/DC, 500mA (optionaly integrated ACU 2000mAh for cca 48h of operation
Buttons	1 or 2 up casing (for each button max 7 numbers progressively dialled)
Relay 2x	switching contact
Max. voltage	48V when I<1A
Max. Current	2A when U<30V
Activation time by code	1 to 99 sec
Activation time by SMS	1 to 99 min
Input:	0/5V
GSM:	
networks	850/900/1800/1900 MHz
SIM	3V, 1.8V

